

### Features

- For AF input stages and driver applications
- High current gain
- Low collector-emitter saturation voltage
- Low noise between 30 Hz and 15 kHz
- Complementary types: BC 846, BC 847, BC 849, BC 850 (NPN)

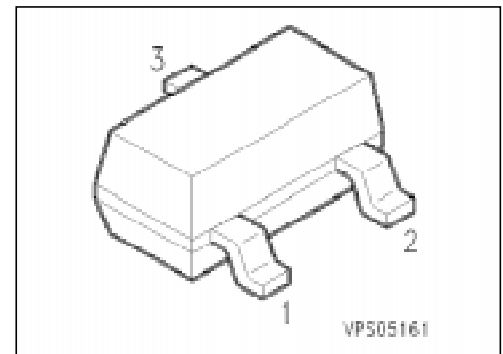

Type	Marking	Ordering Code (tape and reel)	Pin Configuration			Package <sup>1)</sup>
			1	2	3	
BC 856 A	3As	Q62702-C1773	B	E	C	SOT-23
BC 856 B	3Bs	Q62702-C1886				
BC 857 A	3Es	Q62702-C1850				
BC 857 B	3Fs	Q62702-C1688				
BC 857 C	3Gs	Q62702-C1851				
BC 858 A	3Js	Q62702-C1742				
BC 858 B	3Ks	Q62702-C1698				
BC 858 C	3Ls	Q62702-C1507				
BC 859 A	4As	Q62702-C1887				
BC 859 B	4Bs	Q62702-C1774				
BC 859 C	4Cs	Q62702-C1761				
BC 860 B	4Fs	Q62702-C1888				
BC 860 C	4Gs	Q62702-C1889				

<sup>1)</sup>For detailed information see chapter Package Outlines.

## Maximum Ratings

Parameter	Symbol	Values			Unit
		BC 856	BC 857 BC 860	BC 858 BC 859	
Collector-emitter voltage	$V_{CE0}$	65	45	30	V
Collector-base voltage	$V_{CB0}$	80	50	30	
Collector-emitter voltage	$V_{CES}$	80	50	30	
Emitter-base voltage	$V_{EB0}$	5	5	5	
Collector current	$I_C$	100			mA
Peak collector current	$I_{CM}$	200			
Peak base current	$I_{BM}$	200			
Peak emitter current	$I_{EM}$	200			
Total power dissipation, $T_s = 71\text{ °C}$	$P_{tot}$	330			mW
Junction temperature	$T_j$	150			°C
Storage temperature range	$T_{stg}$	- 65 ... + 150			

## Thermal Resistance

Junction - ambient <sup>1)</sup>	$R_{th JA}$	≤ 310	K/W
Junction - soldering point	$R_{th JS}$	≤ 240	

<sup>1)</sup>Package mounted on epoxy pcb 40 mm × 40 mm × 1.5 mm/6 cm<sup>2</sup> Cu.

## Electrical Characteristics

at  $T_A = 25\text{ °C}$ , unless otherwise specified.

Parameter	Symbol	Values			Unit
		min.	typ.	max.	

### DC characteristics

Collector-emitter breakdown voltage $I_C = 10\text{ mA}$	$V_{(BR)CE0}$	BC 856	65	—	—	V
		BC 857, BC 860	45	—	—	
		BC 858, BC 859	30	—	—	
Collector-base breakdown voltage $I_C = 10\text{ }\mu\text{A}$	$V_{(BR)CB0}$	BC 856	80	—	—	
		BC 857, BC 860	50	—	—	
		BC 858, BC 859	30	—	—	
Collector-emitter breakdown voltage $I_C = 10\text{ }\mu\text{A}, V_{BE} = 0$	$V_{(BR)CES}$	BC 856	80	—	—	
		BC 857, BC 860	50	—	—	
		BC 858, BC 859	30	—	—	
Emitter-base breakdown voltage $I_E = 1\text{ }\mu\text{A}$	$V_{(BR)EB0}$		5	—	—	
Collector cutoff current $V_{CB} = 30\text{ V}$ $V_{CB} = 30\text{ V}, T_A = 150\text{ °C}$	$I_{CB0}$		—	1	15	nA
				—	—	4
DC current gain $I_C = 10\text{ }\mu\text{A}, V_{CE} = 5\text{ V}$	$h_{FE}$	BC 856 A ... BC 859 A	—	140	—	—
		BC 856 B ... BC 860 B	—	250	—	
		BC 857 C ... BC 860 C	—	480	—	
$I_C = 2\text{ mA}, V_{CE} = 5\text{ V}$	$h_{FE}$	BC 856 A ... BC 859 A	125	180	250	
		BC 856 B ... BC 860 B	220	290	475	
		BC 857 C ... BC 860 C	420	520	800	
Collector-emitter saturation voltage <sup>1)</sup> $I_C = 10\text{ mA}, I_B = 0.5\text{ mA}$ $I_C = 100\text{ mA}, I_B = 5\text{ mA}$	$V_{CEsat}$		—	75	300	mV
				—	250	
Base-emitter saturation voltage <sup>1)</sup> $I_C = 10\text{ mA}, I_B = 0.5\text{ mA}$ $I_C = 100\text{ mA}, I_B = 5\text{ mA}$	$V_{BEsat}$		—	700	—	
				—	850	
Base-emitter voltage $I_C = 2\text{ mA}, V_{CE} = 5\text{ V}$ $I_C = 10\text{ mA}, V_{CE} = 5\text{ V}$	$V_{BE(on)}$		600	650	750	
				—	—	

<sup>1)</sup>Pulse test:  $t \leq 300\text{ }\mu\text{s}$ ,  $D = 2\text{ %}$ .

**Electrical Characteristics**

at  $T_A = 25\text{ }^\circ\text{C}$ , unless otherwise specified.

Parameter	Symbol	Values			Unit
		min.	typ.	max.	

**AC characteristics**

Transition frequency $I_C = 20\text{ mA}$ , $V_{CE} = 5\text{ V}$ , $f = 100\text{ MHz}$	$f_T$	–	250	–	MHz
Output capacitance $V_{CB} = 10\text{ V}$ , $f = 1\text{ MHz}$	$C_{obo}$	–	3	–	pF
Input capacitance $V_{CB} = 0.5\text{ V}$ , $f = 1\text{ MHz}$	$C_{ibo}$	–	8	–	
Short-circuit input impedance $I_C = 2\text{ mA}$ , $V_{CE} = 5\text{ V}$ , $f = 1\text{ kHz}$ BC 856 A ... BC 859 A BC 856 B ... BC 860 B BC 857 C ... BC 860 C	$h_{11e}$	–	2.7 4.5 8.7	–	k $\Omega$
Open-circuit reverse voltage transfer ratio $I_C = 2\text{ mA}$ , $V_{CE} = 5\text{ V}$ , $f = 1\text{ kHz}$ BC 856 A ... BC 859 A BC 856 B ... BC 860 B BC 857 C ... BC 860 C	$h_{12e}$	–	1.5 2.0 3.0	–	$10^{-4}$
Short-circuit forward current transfer ratio $I_C = 2\text{ mA}$ , $V_{CE} = 5\text{ V}$ , $f = 1\text{ kHz}$ BC 856 A ... BC 859 A BC 856 B ... BC 860 B BC 857 C ... BC 860 C	$h_{21e}$	–	200 330 600	–	–
Open-circuit output admittance $I_C = 2\text{ mA}$ , $V_{CE} = 5\text{ V}$ , $f = 1\text{ kHz}$ BC 856 A ... BC 859 A BC 856 B ... BC 860 B BC 857 C ... BC 860 C	$h_{22e}$	–	18 30 60	–	$\mu\text{S}$
Noise figure $I_C = 0.2\text{ mA}$ , $V_{CE} = 5\text{ V}$ , $R_S = 2\text{ k}\Omega$ $f = 30\text{ Hz} \dots 15\text{ kHz}$ $f = 1\text{ kHz}$ , $\Delta f = 200\text{ Hz}$ BC 859 BC 860 BC 859 BC 860	$F$	–	1.2 1.0 1.0 1.0	4 3 4 4	dB
Equivalent noise voltage $I_C = 0.2\text{ mA}$ , $V_{CE} = 5\text{ V}$ , $R_S = 2\text{ k}\Omega$ $f = 10\text{ Hz} \dots 50\text{ Hz}$ BC 860	$V_n$	–	–	0.110	$\mu\text{V}$

**Total power dissipation  $P_{tot} = f(T_A^*; T_S)$**   
 \* Package mounted on epoxy

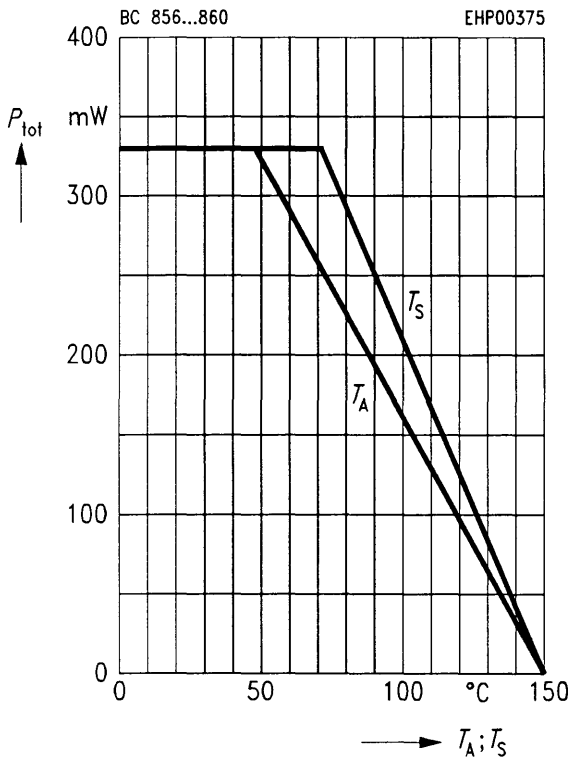

**Collector-base capacitance  $C_{CB0} = f(V_{CB0})$**   
**Emitter-base capacitance  $C_{EB0} = f(V_{EB0})$**

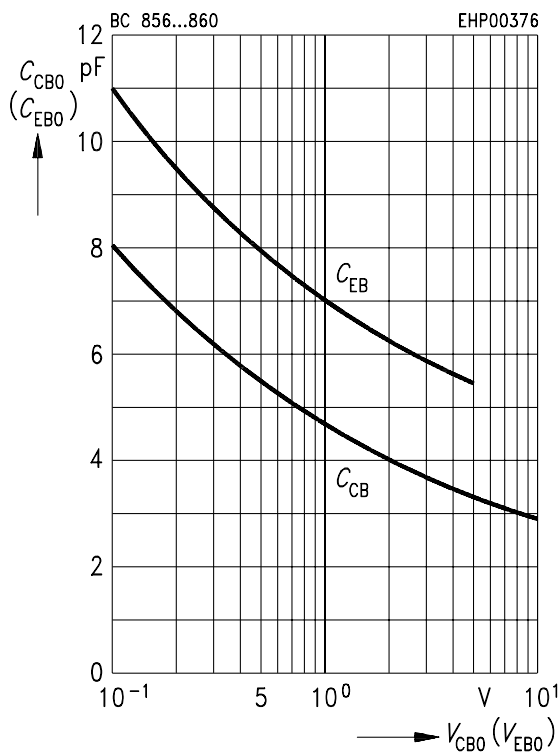

**Permissible pulse load  $P_{tot max}/P_{tot DC} = f(t_p)$**

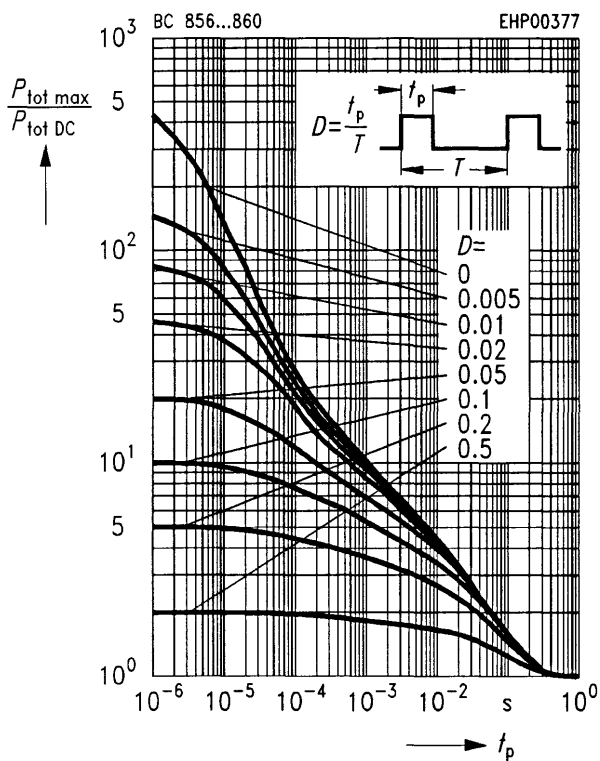

**Transition frequency  $f_T = f(I_C)$**   
 $V_{CE} = 5 V$

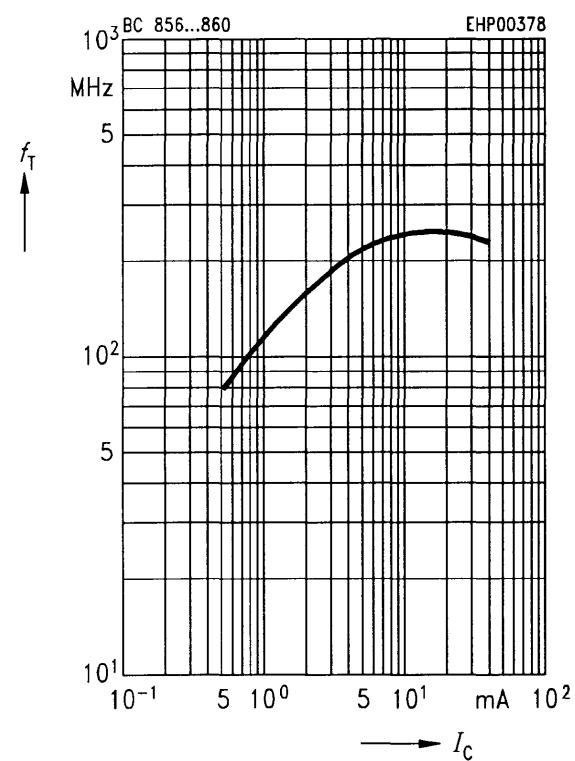

**Collector cutoff current  $I_{CB0} = f(T_A)$**

$V_{CB} = 30\text{ V}$

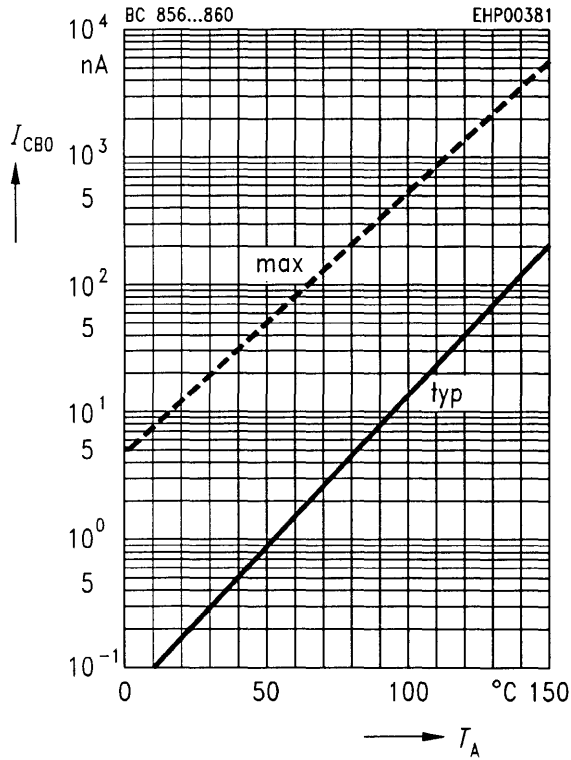

**Collector-emitter saturation voltage**

$I_C = f(V_{CEsat}), h_{FE} = 20$

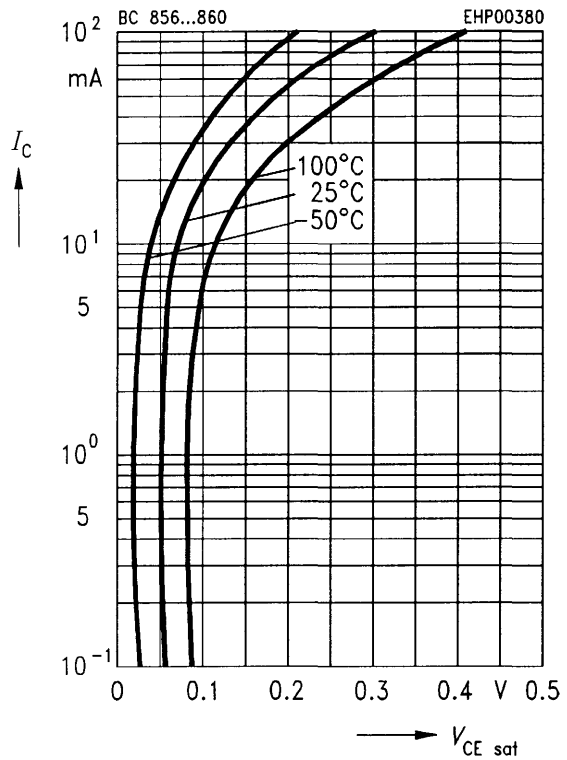

**DC current gain  $h_{FE} = f(I_C)$**

$V_{CE} = 5\text{ V}$

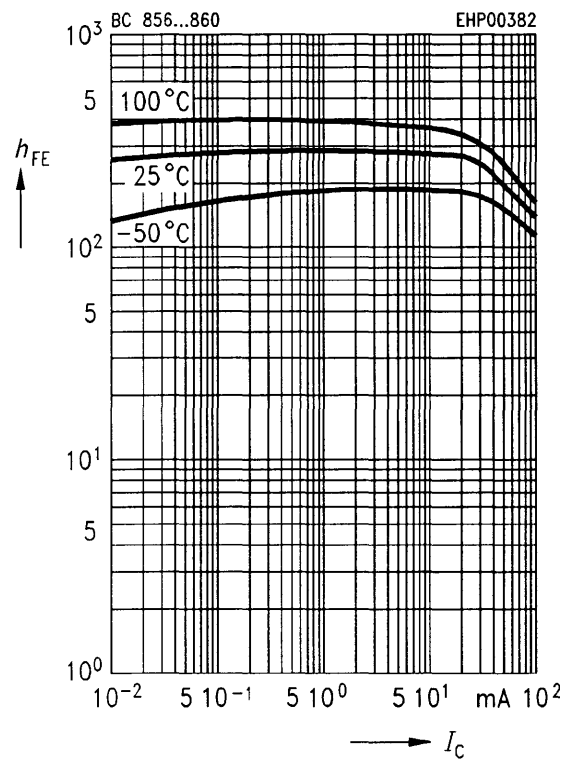

**Base-emitter saturation voltage**

$I_C = f(V_{BEsat}), h_{FE} = 20$

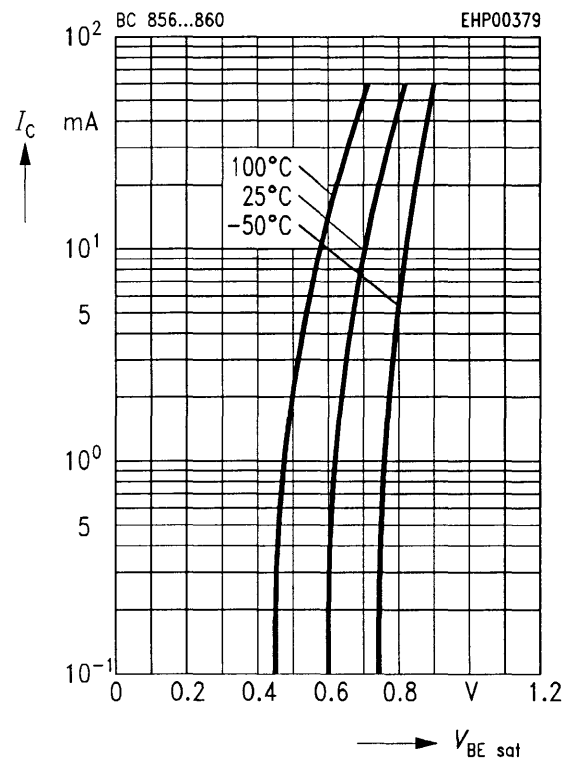

**h parameter  $h_e = f(I_C)$  normalized**

$V_{CE} = 5\text{ V}$

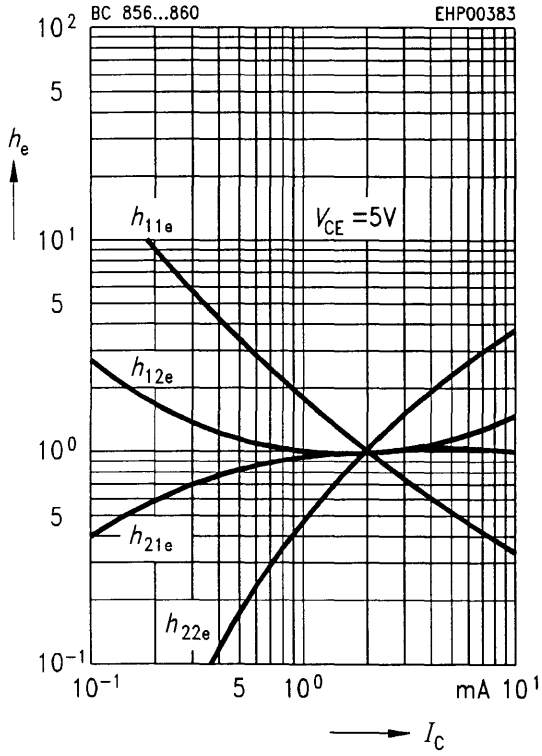

**h parameter  $h_e = f(V_{CE})$  normalized**

$I_C = 2\text{ mA}$

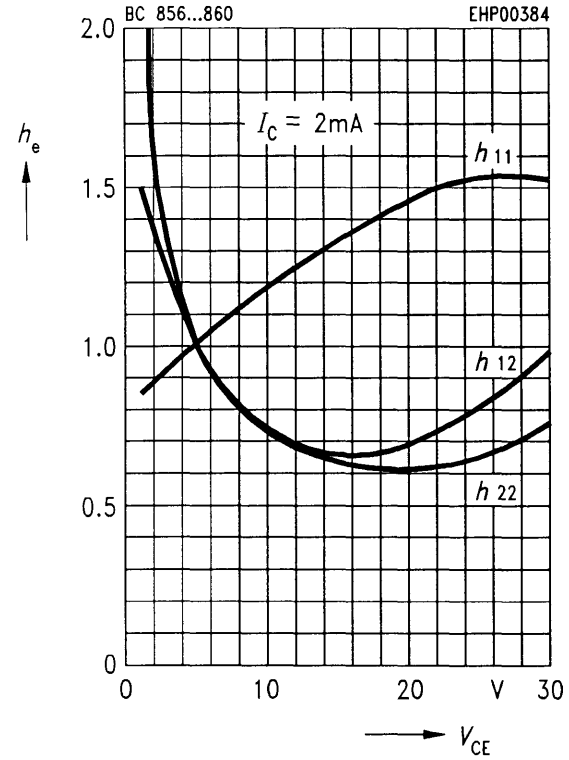

**Noise figure  $F = f(V_{CE})$**

$I_C = 0.2\text{ mA}$ ,  $R_S = 2\text{ k}\Omega$ ,  $f = 1\text{ kHz}$

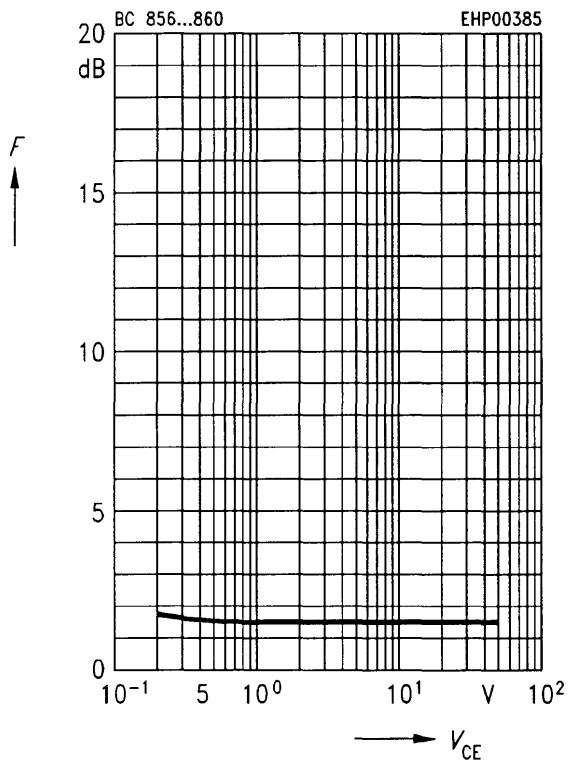

**Noise figure  $F = f(f)$**

$I_C = 0.2\text{ mA}$ ,  $R_S = 2\text{ k}\Omega$ ,  $V_{CE} = 5\text{ V}$

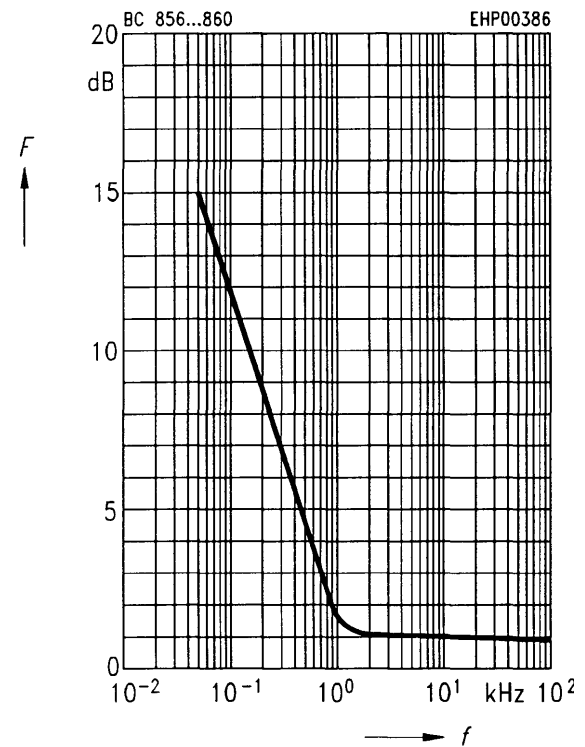

**Noise figure  $F = f(I_C)$**

$V_{CE} = 5\text{ V}, f = 120\text{ Hz}$

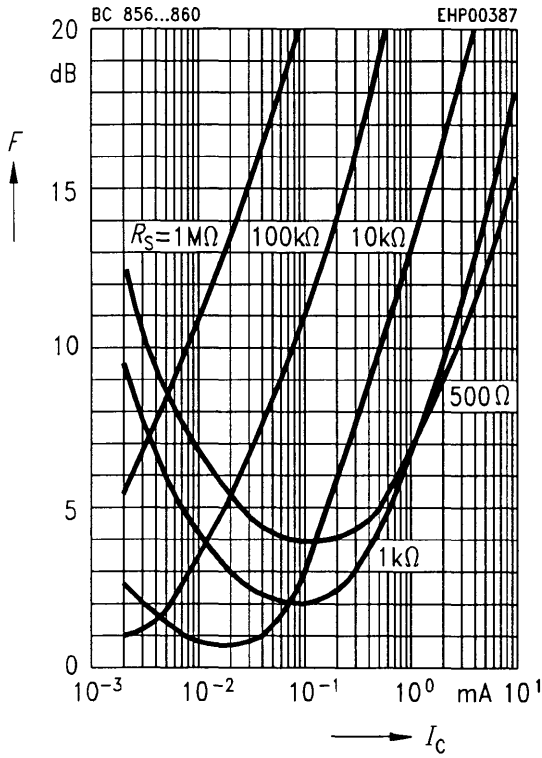

**Noise figure  $F = f(I_C)$**

$V_{CE} = 5\text{ V}, f = 1\text{ kHz}$

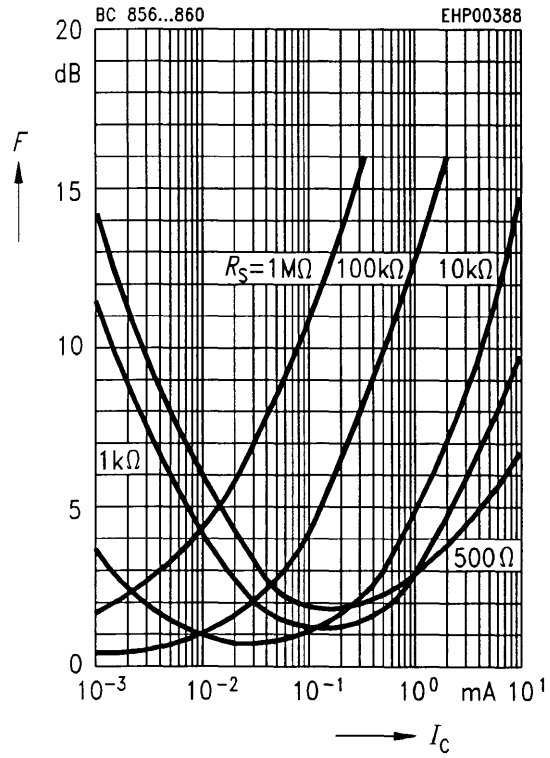

**Noise figure  $F = f(I_C)$**

$V_{CE} = 5\text{ V}, f = 10\text{ kHz}$

